

**TRINISIC® PRO**  
**Models/Modelos/Modèles**  
**9659-DST & 9659T-DST**

For models produced after 01/01/2018 see pages 1 & 2.

For models produced before 01/01/2018 see pages 3 & 4.

Para los modelos producidos después del 01/01/2018, consulte las páginas 1 y 2.

Para los modelos producidos antes del 01/01/2018, consulte las páginas 3 y 4.

Pour les modèles produits après le 01/01/2018, voir pages 1 et 2.

Pour les modèles produits avant le 01/01/2018, voir pages 3 et 4.

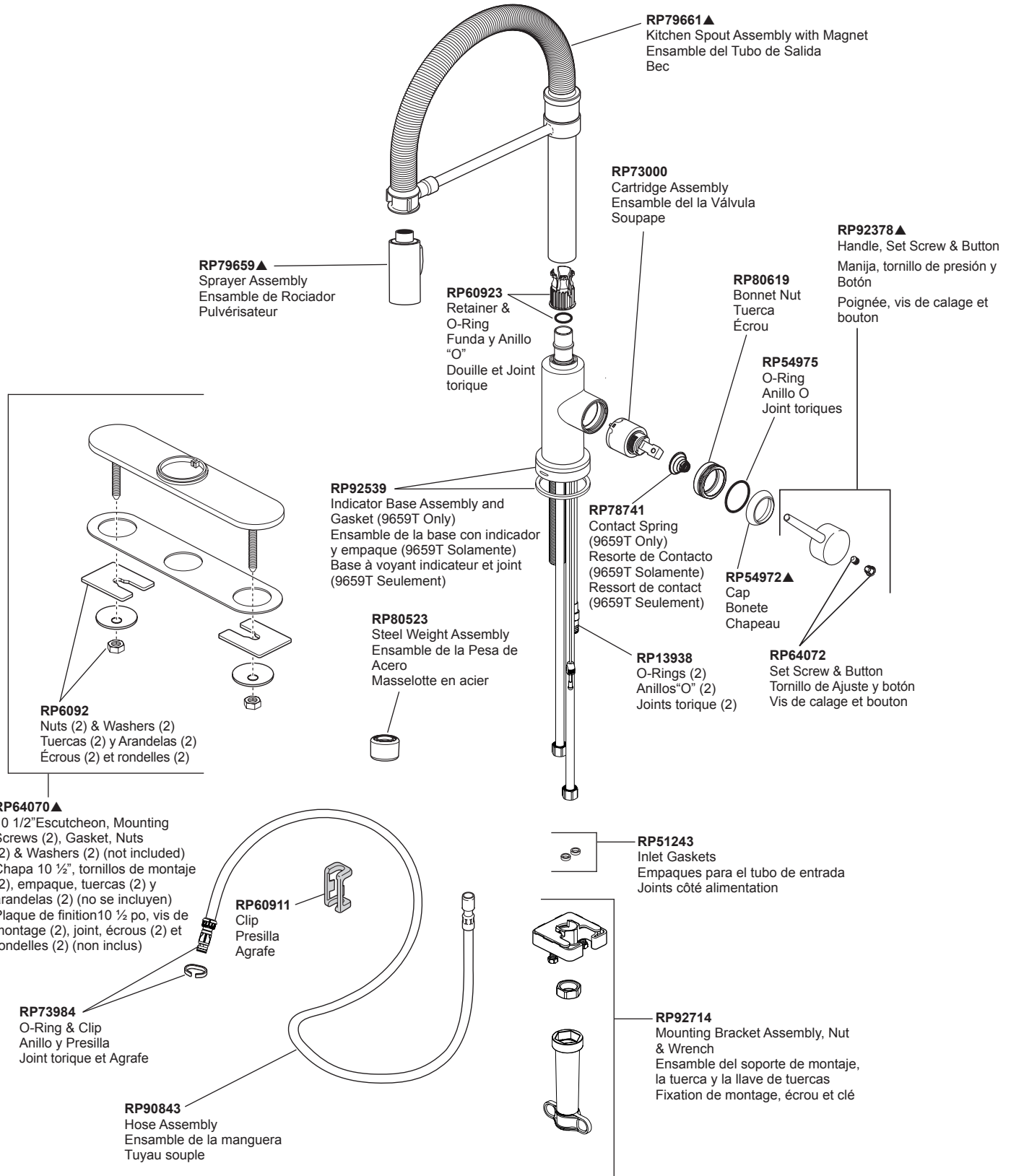

▲Specify Finish / Especificque el Acabado / Précisez le Fini

**EP92546**  
Solenoid Assembly  
Ensamble de Solenoide  
Électrovanne

For PC, SS, AR & KS finishes, order **EP92546**  
For PL, MW, RB & SP finishes, order **EP92546**

Para acabados PC, SS, AR y KS, ordene **EP92546**  
Para acabados PL, MW, RB y SP, ordene **EP92546**

Pour les finis PC, SS, AR et KS, commandez **EP92546**  
Pour les finis PL, MW, RB et SP, commandez **EP92546**

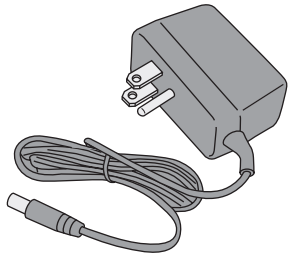

**EP73954**  
9 Volt Power Supply  
(Accessory Order Only)  
Fuente de alimentación de 9 voltios  
(Orden de accesorios solamente)  
Alimentation électrique 9 volts  
(L'accessoire seulement)

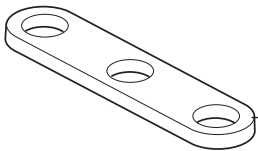
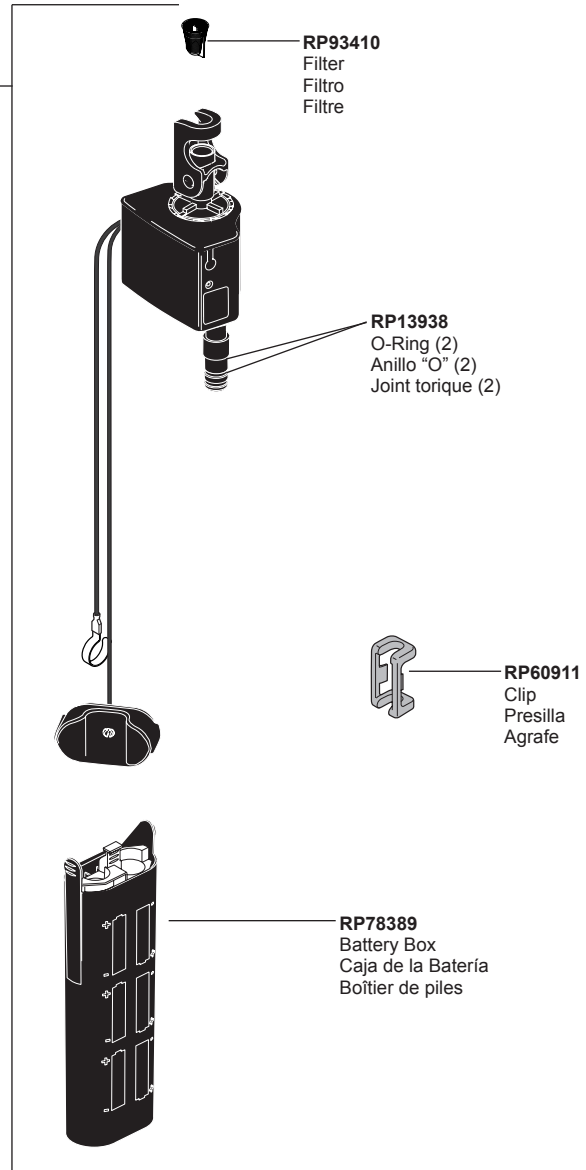

**RP37490**  
Thin Deck Aid (Not Included)  
Soporte para encimera delgada  
(No incluido)  
Plaque de renfort (non incluse)

Other useful accessories that may be purchased separately.  
Otros accesorios útiles que se pueden comprar por separado.  
Autres accessoires utiles pouvant être achetés séparément.

**RP63263**  
Adapters  
3/8"-24 UNEF to 1/2"-20 UN &  
3/8"-24 UNEF to 1/2"-14 NPSM  
Adaptadors  
3/8"-24 UNEF a 1/2"-20 UN &  
3/8"-24 UNEF a 1/2"-14 NPSM  
Adaptateurs  
3/8 po-24 UNEF à 1/2 po-20 UN et  
3/8 po-24 UNEF à 1/2 po-14 NPSM

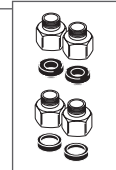

**RP63264**  
Adapters (10) 3/8"-24 UNEF to 1/2"-20 UN  
Adaptadors (10) 3/8"-24 UNEF a 1/2"-20 UN  
Adaptateurs (10) 3/8 po-24 UNEF à 1/2 po-20 UN



**RP63265**  
Adapters (10) 3/8"-24 UNEF to 1/2"-14 NPSM  
Adaptadors (10) 3/8"-24 UNEF a 1/2"-14 NPSM  
Adaptateurs (10) 3/8 po-24 UNEF à 1/2 po-14 NPSM



# TRINSIC® PRO

Models/Modelos/Modèles

9659-DST, 9659-AR-DST,

9659T-DST & 9659T-AR-DST

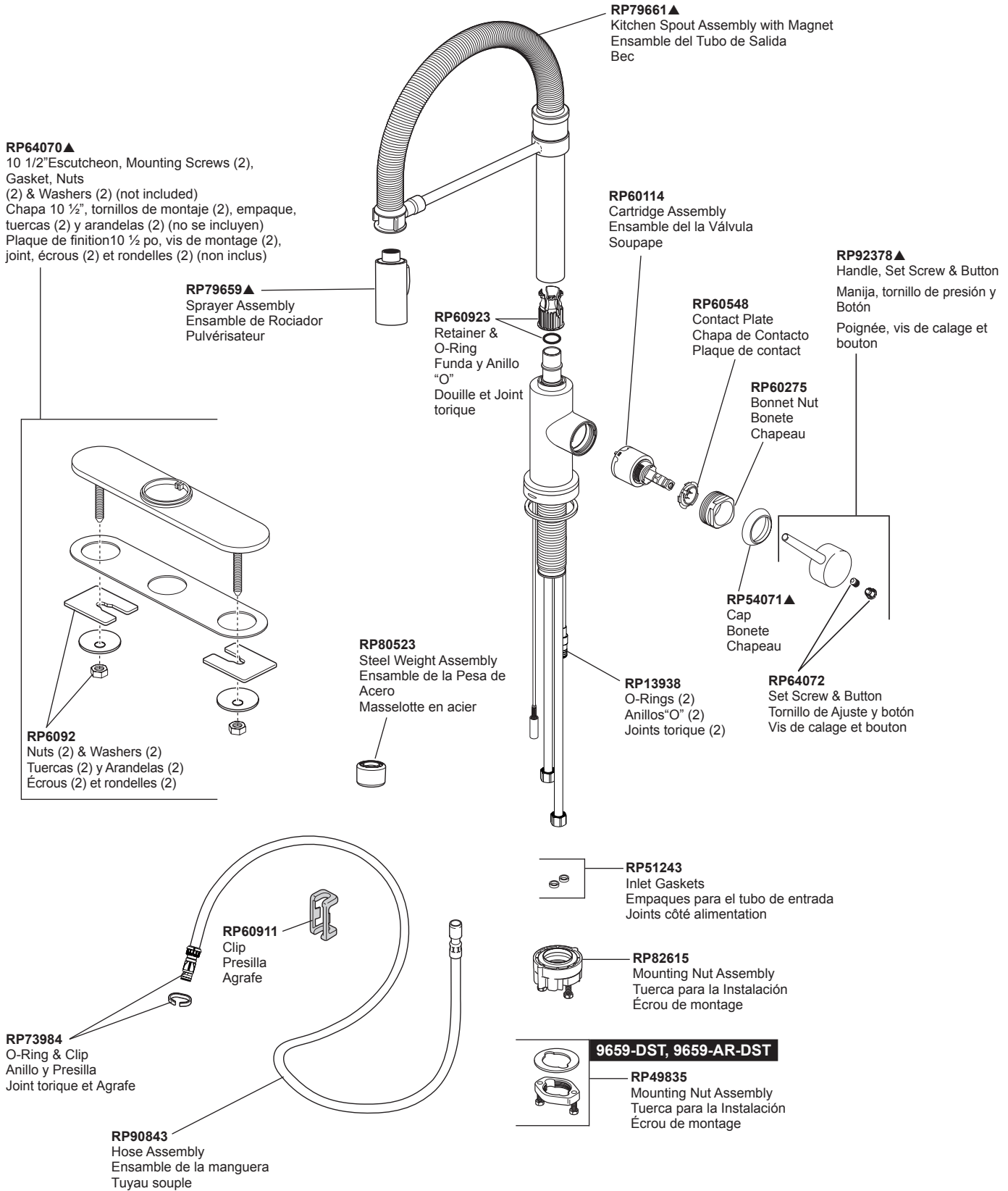

▲Specify Finish / Especificque el Acabado / Précisez le Fini

**EP74855**  
Solenoid Assembly  
Ensamble de Solenoide  
Électrovanne

For PC, SS, AR & KS finishes, order **EP74855XX**  
For PL, MW, RB & SP finishes, order **EP74855XX**

Para acabados PC, SS, AR y KS, ordene **EP74855XX**  
Para acabados PL, MW, RB y SP, ordene **EP74855XX**

Pour les finis PC, SS, AR et KS, commandez **EP74855XX**  
Pour les finis PL, MW, RB et SP, commandez **EP74855XX**

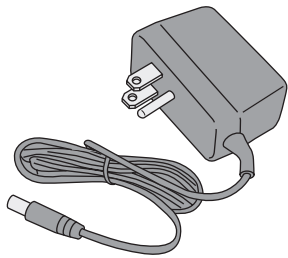

**EP73954**  
9 Volt Power Supply  
(Accessory Order Only)  
Fuente de alimentación de 9 voltios  
(Orden de accesorios solamente)  
Alimentation électrique 9 volts  
(L'accessoire seulement)

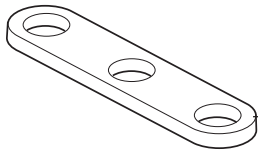

**RP37490**  
Thin Deck Aid (Not Included)  
Soporte para encimera delgada  
(No incluido)  
Plaque de renfort (non incluse)

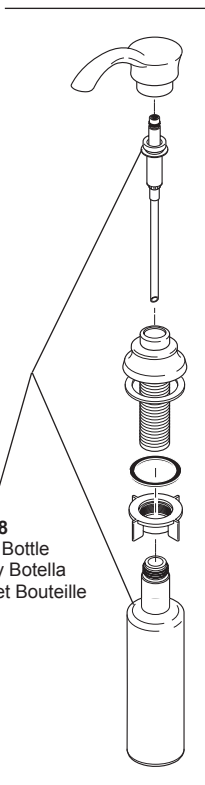

**RP47888**  
Pump & Bottle  
Bomba y Botella  
Pompe et Bouteille



**RP50952**  
Cut - To - Fit Plastic Sleeves  
Casquillos cortados a la medida  
Bagues d'extrémité pour tubes coupés

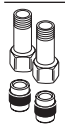

**RP53468**  
Check Valves  
Válvulas Checadoras  
Clapets de non-retour

**RP71543 ▲**

Soap Dispenser  
(Accessory Order Only)  
Dispensador de jabón  
(Orden de Accesorio Solamente)  
Distributeur de savon  
(Livrabre séparément seulement)

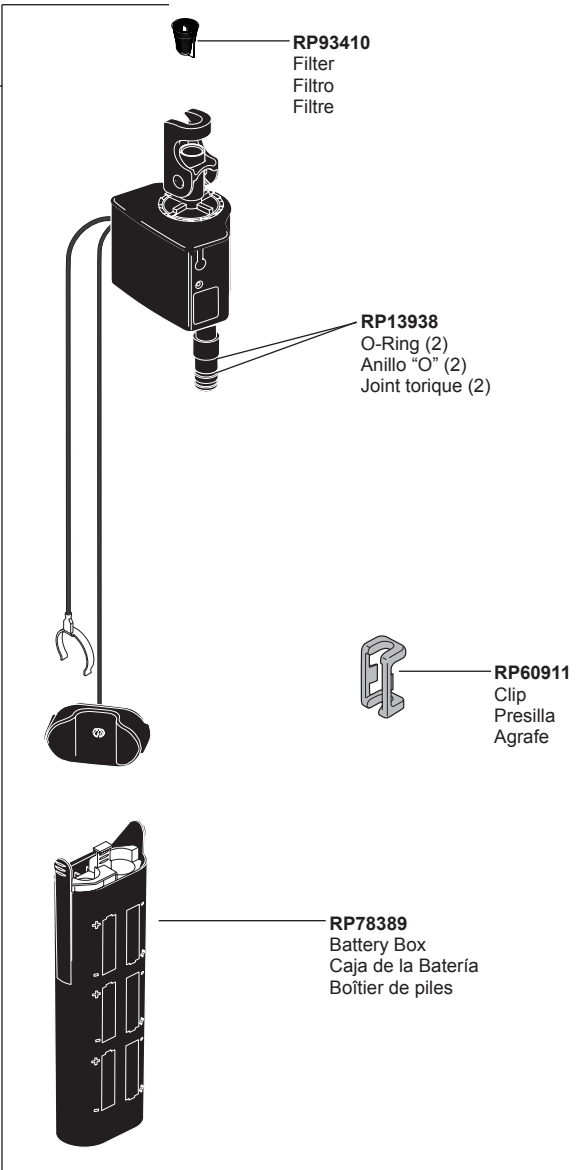

**RP93410**  
Filter  
Filtro  
Filtre

**RP13938**  
O-Ring (2)  
Anillo "O" (2)  
Joint torique (2)

**RP60911**  
Clip  
Presilla  
Agrafe

**RP78389**  
Battery Box  
Caja de la Batería  
Boîtier de piles

Other useful accessories that may be purchased separately.  
Otros accesorios útiles que se pueden comprar por separado.  
Autres accessoires utiles pouvant être achetés séparément.

**RP63263**

Adapters  
3/8"-24 UNEF to 1/2"-20 UN &  
3/8"-24 UNEF to 1/2"-14 NPSM  
Adaptadors  
3/8"-24 UNEF a 1/2"-20 UN &  
3/8"-24 UNEF a 1/2"-14 NPSM  
Adaptateurs  
3/8 po-24 UNEF à 1/2 po-20 UN et  
3/8 po-24 UNEF à 1/2 po-14 NPSM

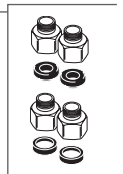

**RP63264**

Adapters (10) 3/8"-24 UNEF to 1/2"-20 UN  
Adaptadors (10) 3/8"-24 UNEF a 1/2"-20 UN  
Adaptateurs (10) 3/8 po-24 UNEF à 1/2 po-20 UN



**RP63265**

Adapters (10) 3/8"-24 UNEF to 1/2"-14 NPSM  
Adaptadors (10) 3/8"-24 UNEF a 1/2"-14 NPSM  
Adaptateurs (10) 3/8 po-24 UNEF à 1/2 po-14 NPSM

